

Guidelines for Planting within Highway Right-of-Way



**Roadside Environmental Unit
Landscape Design & Development
1557 Mail Service Center
Raleigh, NC 27699-1557
(919)733.2920**

GUIDELINES FOR PLANTING WITHIN HIGHWAY RIGHT-OF-WAY

The aesthetic quality of North Carolina's roadsides is influenced by a number of factors. Among these factors are right-of-way width, adjacent land use, topography, overhead utilities, signage, and existing vegetation.

In order to protect the public investment in highways the North Carolina Department of Transportation Division of Highways uses grass and legume cover to prevent roadside erosion and shrubs, trees and wildflower plantings to reduce mowing areas and improve roadside aesthetics.

Shrubs and trees within highway rights-of-way result by retaining desirable vegetation during initial highway construction, allowing natural regeneration, or planting/reforesting selected areas. Limited funding and manpower prevent the North Carolina Division of Highways from planting and maintaining shrubs and trees on all roadsides. Planting and maintenance of specific roadside areas is frequently undertaken by municipalities, garden clubs, or individuals after permission is granted from the Division of Highways.

North Carolina General Statute 136-93 provided,

" . . . no tree or shrub in or on any State road or State highways shall be planted, trimmed, or removed, . . . without a written permit, and then only in accordance with the regulations of said Department of Transportation or its duly authorized officers or employees; and the work shall be under the supervision and to the satisfaction of the Department of Transportation or its officers or employees, and the entire expense of replacing the highway in as good condition as before shall be paid by the persons, firms, or corporations to whom the permit is given, or by whom the work is done."

**Included herein are guidelines for obtaining permits and for planting
within highway right-of-way.**



PROCEDURES FOR HANDLING REQUESTS FOR PERMITS FOR PLANTING ON HIGHWAY RIGHT-OF-WAY

Many requests are received from municipalities, civic organizations, and individuals for permission to plant within highway right-of-way. In order to protect the public investment and to promote safety, utility, economy, and beauty in highways, the following procedures for handling planting requests have been developed:

Interstate and Other Controlled Access Highways

Planting by other than Division of Highways personnel on Interstate or other Controlled-Access Highways is discouraged. These facilities are designed for high speed, unencumbered traffic movement and are usually fenced to prevent people, animals, or other impediments from entering the rights-of-way. The safety of highway users is paramount. Considerable traffic control devices and procedures are required when work is being done within these rights-of-way.

In those instances where planting is desired by other than Division of Highways personnel, the requesting party should arrange a conference with the Roadside Environmental Field Operations Engineers who will explain Division of Highways criteria for sight distances, recovery areas, and minimum setback distances. Following this explanation, the requesting party must prepare a detailed planting plan (to scale) describing the various species of plants to be used and the proposed locations of plants. The plan is to be submitted to the Division Engineer for approval.

Other State System Right-of-Way

The attached Guidelines for Tree, Shrub, and Groundcover Planting on Highway Right-of-Way other than Controlled-Access or Interstate are to be followed.

Upon receipt of a request for planting, accompanied by a plan and typical cross section, the Division Engineer or his representative, in conjunction with the Roadside Environmental Field Operations Engineers, will make an on-site investigation of the proposed planting. If the planting proposal does not conform with the attached guidelines, the request may be denied by the Division Engineer. If the proposed planting conforms with Department guidelines and policies, the Division Engineer will issue a letter-type permit for planting (with a copy of such permit, together with a plan and typical cross section, to the State Roadside Environmental Engineer).

Before any action will be taken on a request for a permit for planting within a municipality, the request must have the approval of the local governing body since the planting permit will be issued to the municipality. Requests for planting outside municipalities will be considered using the attached guidelines and permits for planting will be issued to the party requesting the permit.

PROCEDURES FOR HANDLING REQUESTS FOR PERMITS FOR PLANTING ON HIGHWAY RIGHT-OF-WAY

Standard conditions to be enumerated in planting permits are:

1. In the event that plants require relocation or removal for highway construction, reconstruction, maintenance or safety, such removal or relocation will be done immediately by the permittee (municipality/civic group/individual) upon notification by the Division of Highways, entirely at the expense of the permittee.
2. The Division of Highways will not be responsible for any damage to the planting which may be done by third parties.
3. Maintenance of the plantings will be the responsibility of Division of Highways or permittee.

Other conditions as determined by the Division Engineer and Roadside Environmental Field Operations Engineers, that are distinctive to the specific planting proposal, will be enumerated along with the standard conditions above.

The Roadside Environmental Unit in Raleigh may be consulted regarding any planting proposal that the Division Engineer and Roadside Environmental Field Operations Engineers determine has merit, but which does not conform with standards as previously described due to extenuating circumstances.

Three Methods by which Planting Request May be Approved:

1. A planting permit can be issued to allow planting and maintenance of the planting by the permittee;
2. The permittee can furnish funds for the plant materials with highway Roadside Environmental forces performing the planting and assuming maintenance of the planting;
3. The Division of Highways can assume the project entirely, bearing the cost of plant materials as well as performing the planting and plant maintenance. These planting projects will normally be included in the Transportation Improvement Program with approved funding by the Board of Transportation.

The Division Engineer must determine the ability of Division forces to assume the additional maintenance (of planting) required before entering an agreement.

The Roadside Environmental Unit Landscape Design & Development personnel may assist the requesting parties in the development of a planting proposal (for the highway right-of-way) as policy and workloads permit.



PLANTING ENCROACHMENT PROCESS WITHIN HIGHWAY RIGHT-OF-WAY

Plan Development

1. Requesting party obtains approval of municipality (only if the right-of way is within a municipality).
2. Conference with the Roadside Environmental Field Operations Engineer to explain planting criteria to the applicant.
 - a) Sight distance
 - b) Recovery areas
 - c) Safety setbacks
 - d) Ditches, shoulders, and utilities
 - e) Maintenance considerations
 - f) Acceptable plant material.
3. Requesting party then submits a planting plan to the Division Engineer, consisting of:
 - a) Scale drawing (include site location, road names, north arrow, name of applicant, graphic scale, etc.).
 - b) Show proposed location of plants.
 - c) Plant list (include botanical names, common names, size, caliper, and spacing).
 - d) Note adjacent land uses.
 - e) Show bridge locations, signage, utilities, existing vegetation, and drainage features.
 - f) Note travel lanes and pavement areas.

Permitting Process

1. Division Engineer requests investigation by the Division Roadside Environmental Engineer and the Roadside Environmental Field Operations Engineer, as appropriate.
2. Division Engineer either denies request or
3. Division Engineer approves request and issues letter-type permit.
 - a) Permit to municipality (if within a municipality)
 - b) Permit to applicant (if not within a municipality).
4. Send copy of the permit to the State Roadside Environmental Engineer

GUIDELINES FOR PLANTING TREES, SHRUBS, AND GROUNDCOVERS WITHIN HIGHWAY RIGHT-OF-WAY

The following are cross sections for highways and streets with posted speed limits as indicated, and plan views of diamond and cloverleaf interchanges; showing guidelines for planting trees, shrubs, and groundcovers. Planting that involves exceptions to these criteria will be considered on an individual basis.

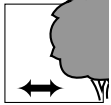

Distance from Travel Lane

The cross sections and plan views show the minimum distances from the curb or the edge of travel lanes for new plantings. Where existing tree distances have been established, replacement trees should conform with established set-back distances.

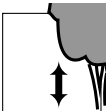

Vertical Clearance

A minimum clearance of 16 feet above the entire pavement width must be maintained at all times and a minimum clearance of 7 feet above sidewalks or pedestrian spaces.



Sight Distances

Shrubs must be kept low, and trees and large shrubs under-trimmed sufficiently to permit clear sight in the area between 2 feet and 6 feet above roadway elevations. Due to widely varying conditions of topography, highway alignment and grade, type and volume of vehicular and pedestrian traffic; necessary sight distances in excess of the minimums described on the following pages must be individual site determinations.



Selection of Plants

Tall-growing trees should not be selected for planting beneath utility lines and wide-spreading trees should not be used unless there is sufficient width of planting area to accommodate them without continued severe pruning. Small trees and large shrubs should be used which are adaptable to under-trimming without destroying their desired appearance.

In curb and gutter areas, groundcover is permissible between curb and shrubs to avoid a narrow mowing strip.



Pavement Removal

When pavement remains beneath traffic channelization islands, such pavement may not be broken or removed without written permission.

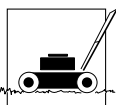

Effect on Mowing and Drainage

Trees should be placed sufficiently far apart, or grouped in shrub beds and mulched in a shape that will facilitate mower operation, avoid excessive mower maneuvering, or hand trimming. Trees/large shrubs shall be minimum of 5 feet behind ditch line (in cut sections) and 5 feet outside shoulder break (in fill sections), or the minimum distance from edge of travel lanes as shown on Typical Sections, whichever is the greater.



Traffic Operation and Safety

All plantings shall be maintained in a condition that will not interfere nor endanger vehicular or pedestrian traffic.

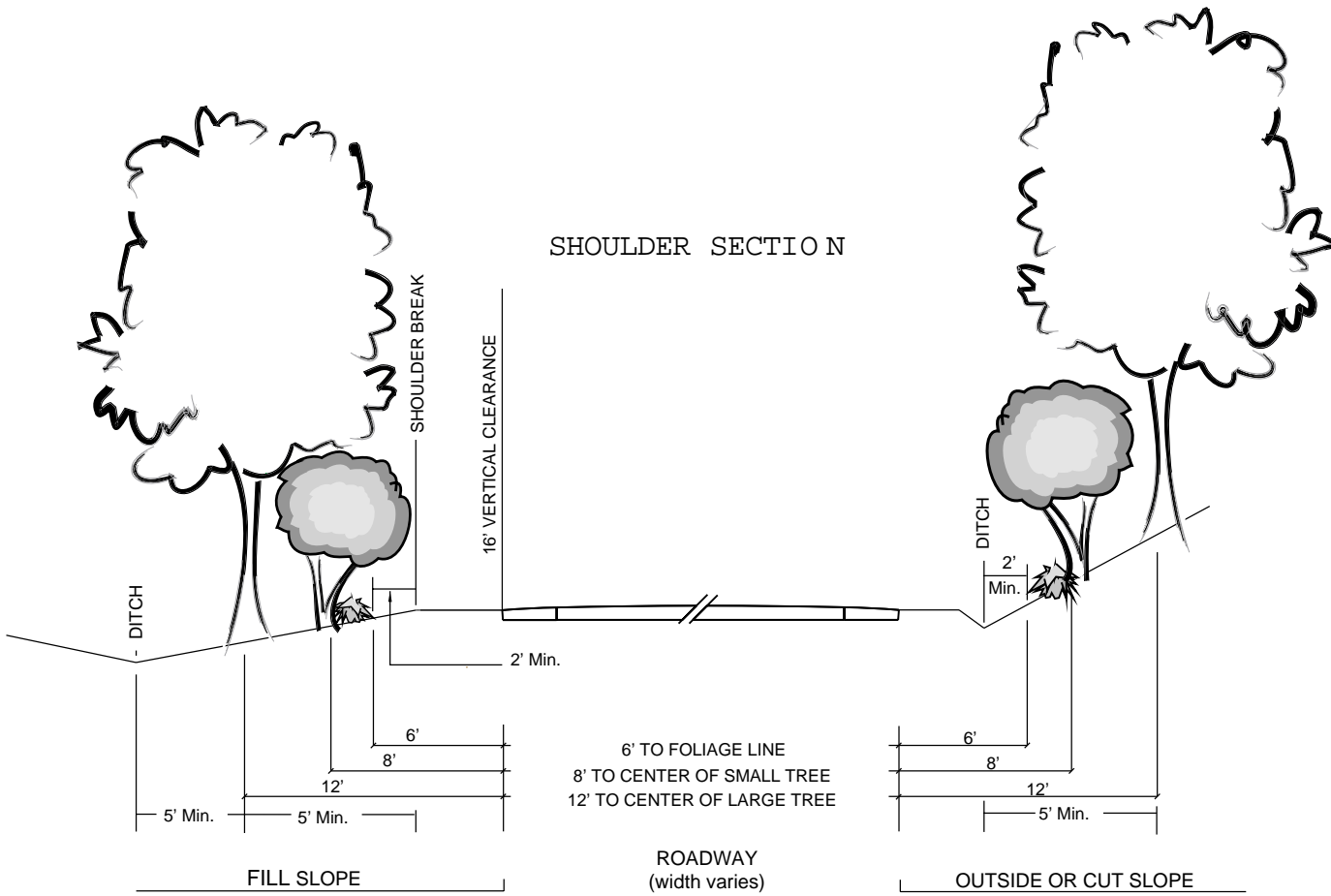
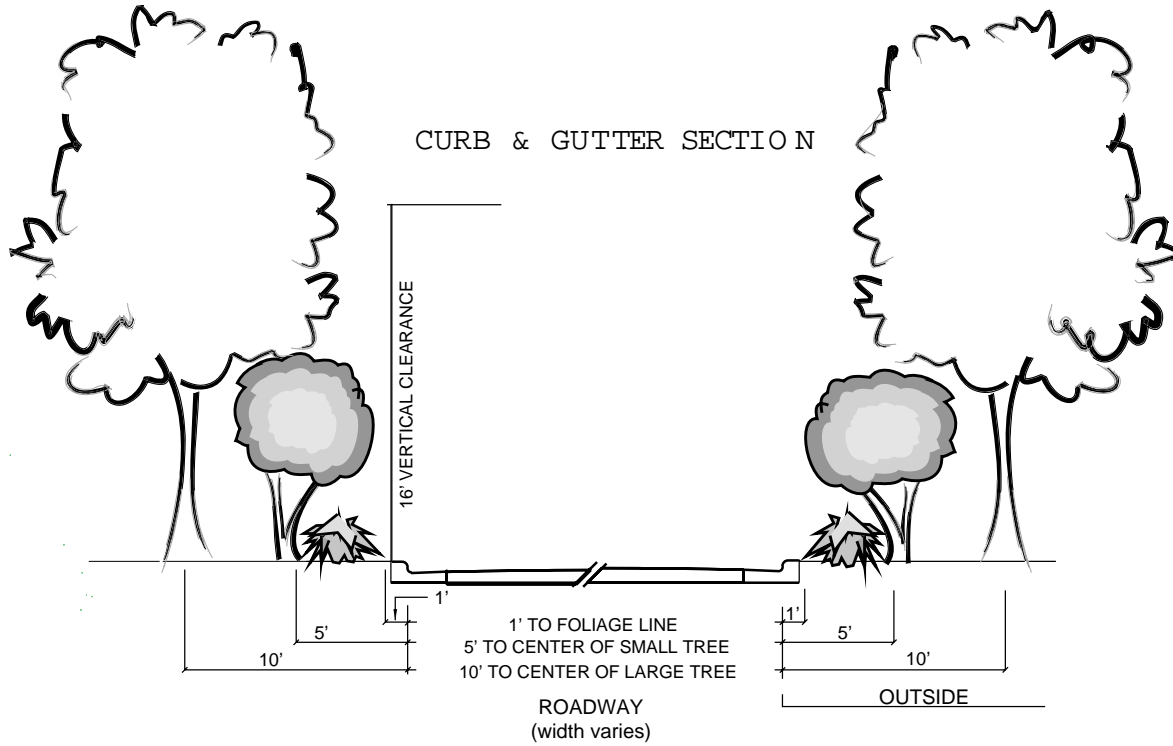

NOTE:
WHEN WIDTH OF SHOULDERS AND DITCHES DO NOT CONFORM WITH THESE TYPICAL SECTIONS, THE 2' MIN. DISTANCE BEHIND THE DITCH AND 2' MIN. DISTANCE OUTSIDE THE SHOULDER BREAK SHALL GOVERN.

CURB & GUTTER SECTION

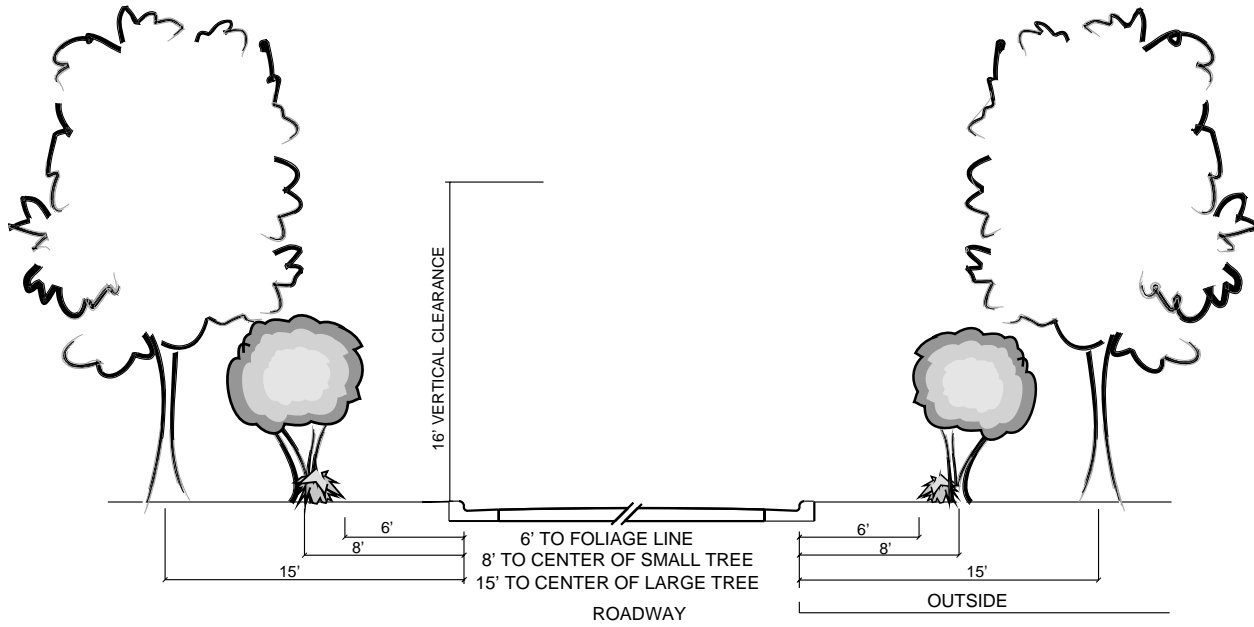

SHOULDER SECTION

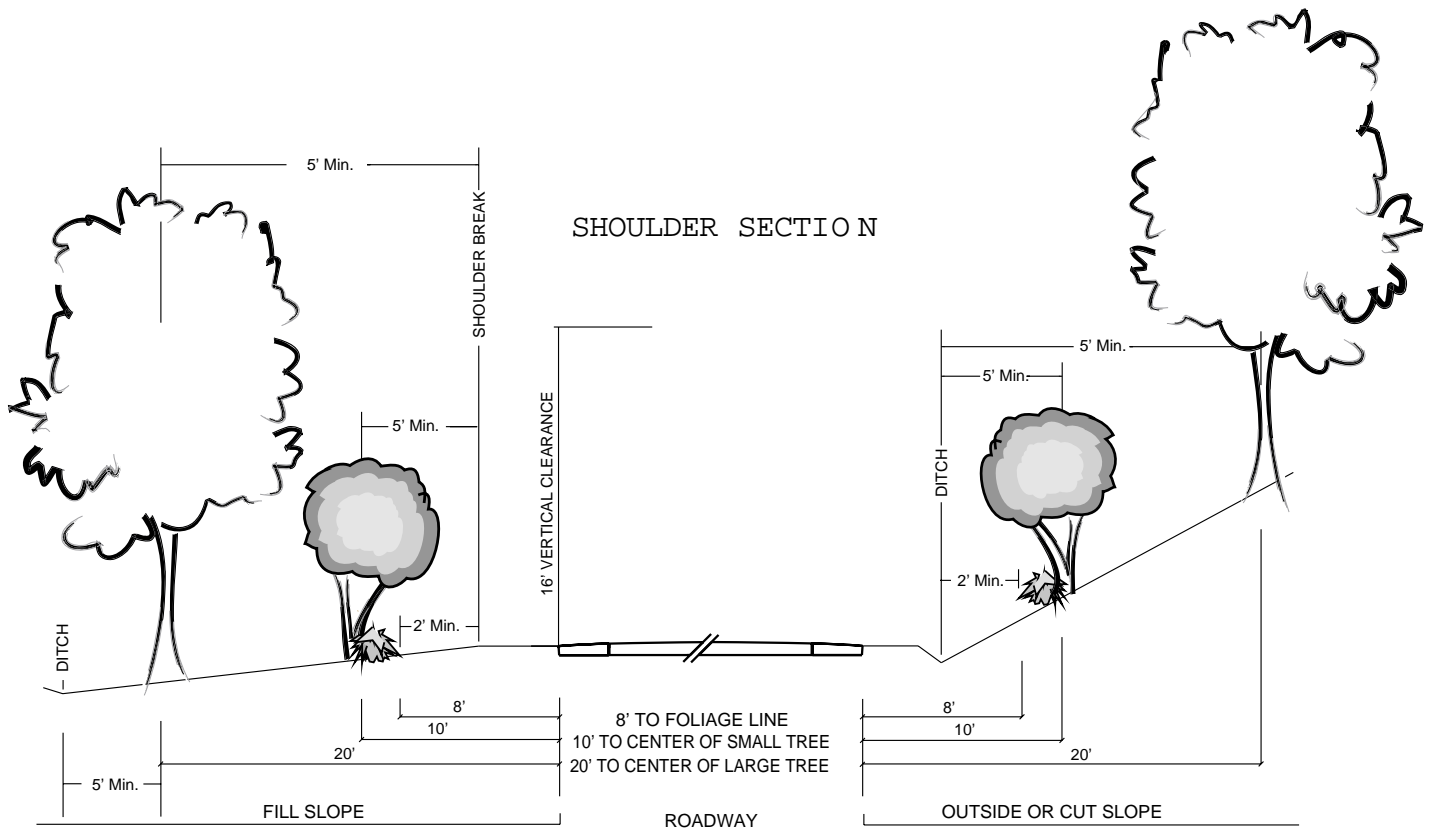

NOTE:
WHEN WIDTH OF SHOULDERS AND DITCHES DO NOT CONFORM WITH THESE TYPICAL SECTIONS, THE 2' MIN. DISTANCE BEHIND THE DITCH AND 2' MIN. DISTANCE OUTSIDE THE SHOULDER BREAK SHALL GOVERN.

LARGE TREE - A TREE WITH ANY SINGLE STEM (TRUNK) GREATER THAN 4" CALIPER (DIAMETER) AT MATURITY.

CURB & GUTTER SECTION

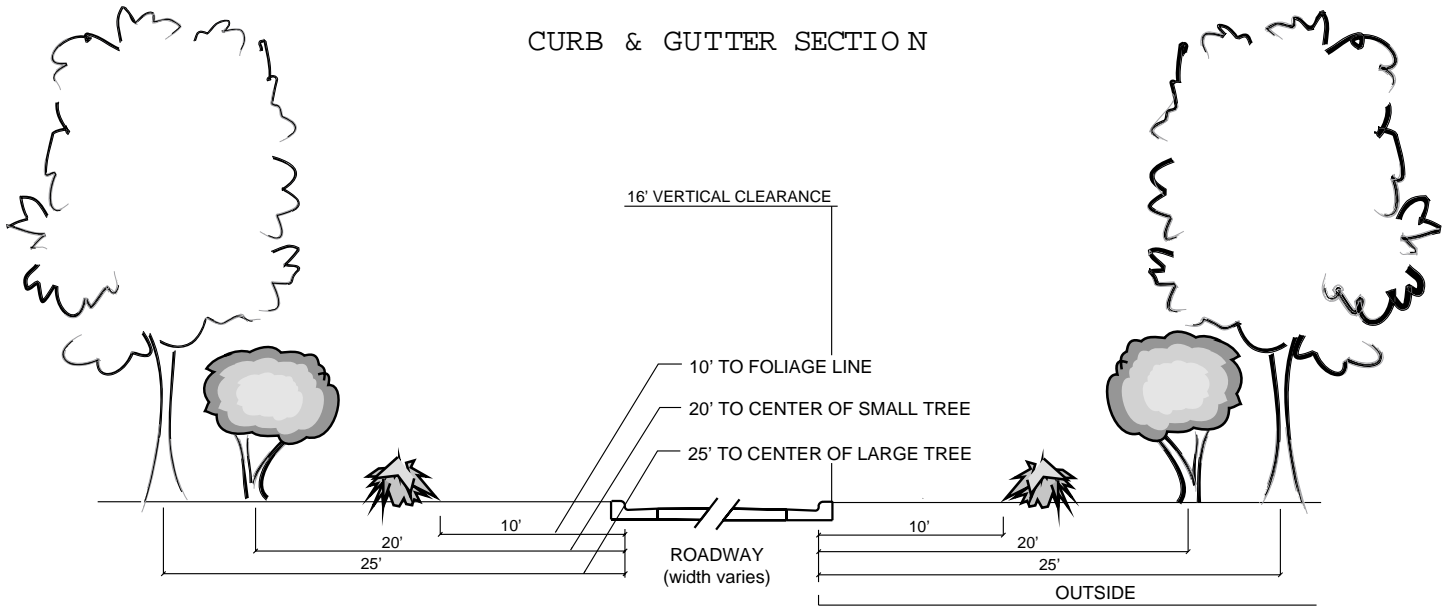

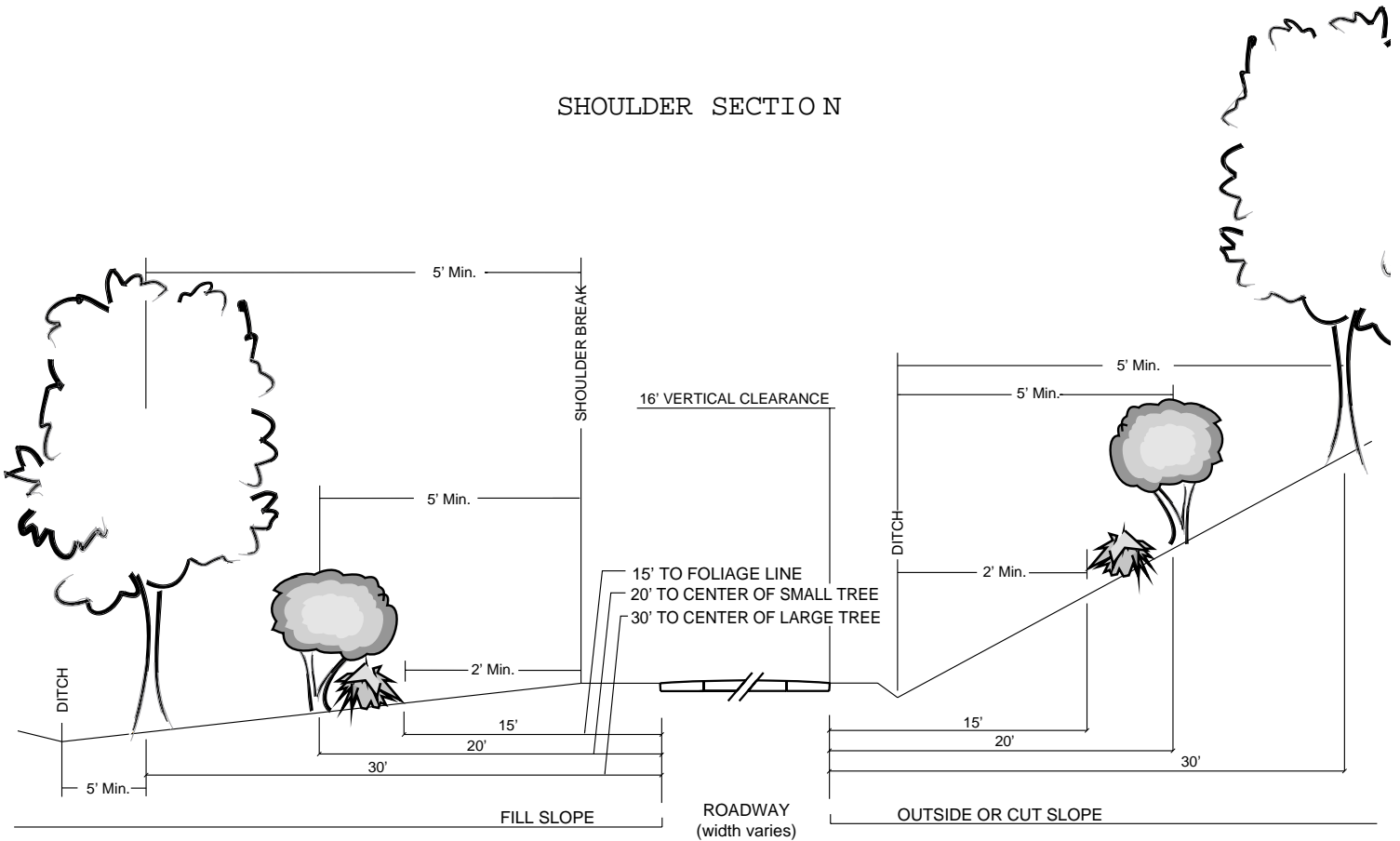

SHOULDER SECTION



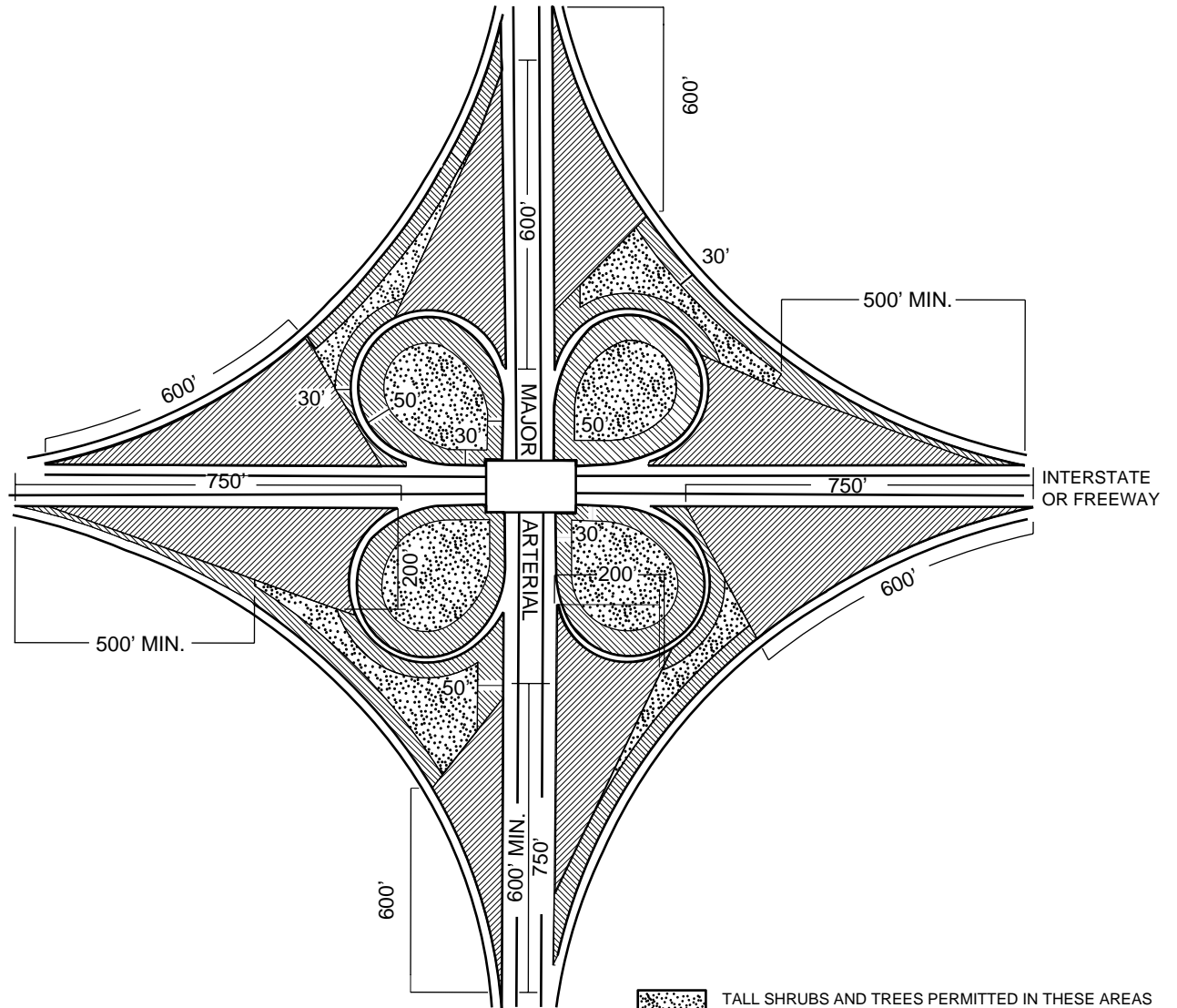
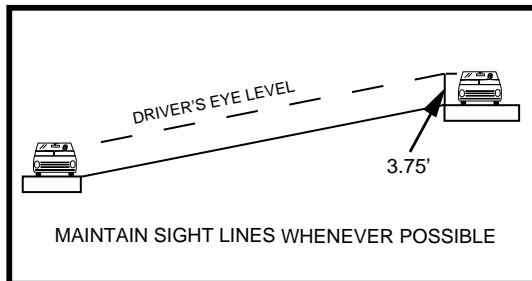
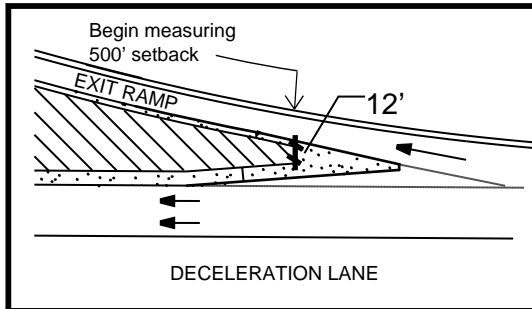
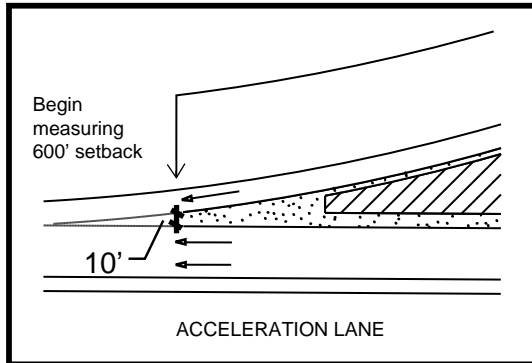

NOTE:
WHEN WIDTH OF SHOULDERS AND DITCHES DO NOT CONFORM WITH THESE TYPICAL SECTIONS, THE 2' MIN. DISTANCE BEHIND THE DITCH AND 2' MIN. DISTANCE OUTSIDE THE SHOULDER BREAK SHALL GOVERN.

guide for Landscape Planting at Cloverleaf Interchanges







 TALL SHRUBS AND TREES PERMITTED IN THESE AREAS WHERE THEY DO NOT EFFECT LIGHTING.

 LOW SHRUBS NOT TO OBSTRUCT DRIVERS VIEW PERMITTED IN THESE AREAS EXCEPT ON SHOULDERS AND DITCHES

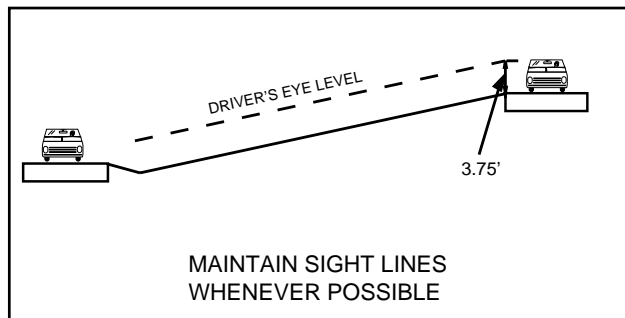
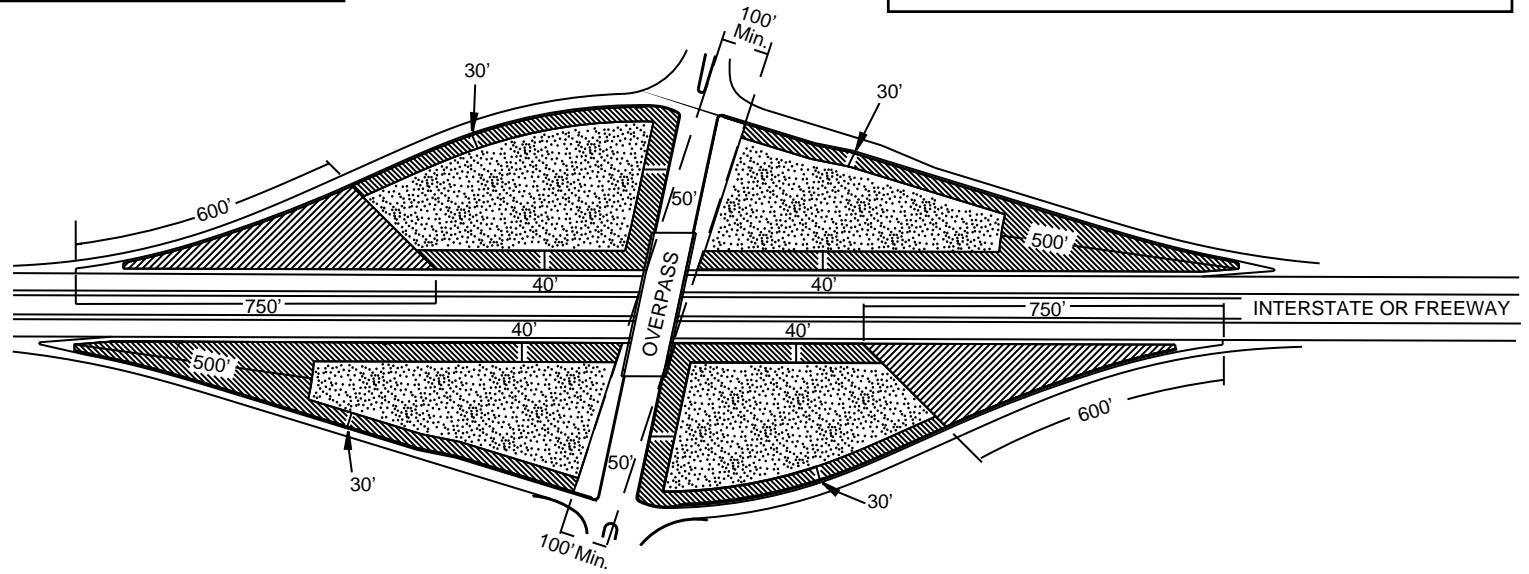
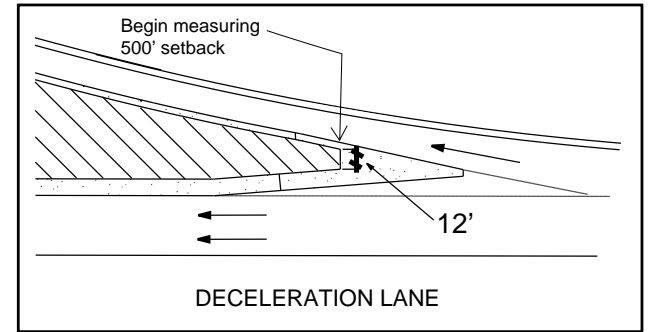
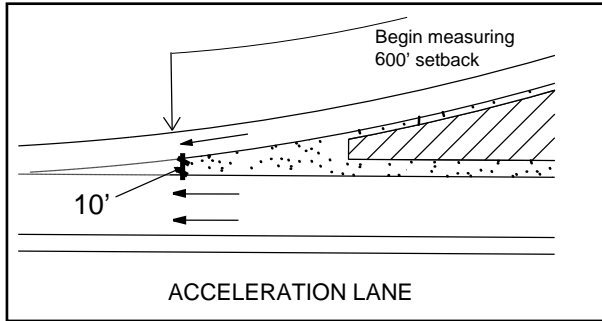
 LOW SHRUBS NOT TO OBSTRUCT DRIVERS VIEW OF THE PAVEMENT ON SHOULDERS AND DITCHES (SEE DETAIL -A-)

guide for Landscape Planting at Diamond Interchanges



-  TALL SHRUBS AND TREES PERMITTED IN THESE AREAS WHERE THEY DO NOT EFFECT LIGHTING.
-  LOW SHRUBS NOT TO OBSTRUCT DRIVERS VIEW PERMITTED IN THESE AREAS EXCEPT ON SHOULDERS AND DITCHES
-  LOW SHRUBS NOT TO OBSTRUCT DRIVERS VIEW OF THE PAVEMENT ON SHOULDERS AND DITCHES (SEE DETAIL -A-)

Planting Suggestions

- ✓ Plants should be planted in their permanent location immediately upon delivery or should be adequately protected until planted.
- ✓ It is not necessary to remove the burlap from the root ball, but the strings from around the stem of the plant must be removed and the burlap should be folded from the top of the ball after the plant is in the hole.
- ✓ The soil around the plant should be tamped to remove air pockets.
- ✓ Mulching, to help retain moisture, is mandatory and should not contain substances which would inhibit normal development and growth of plants.
- ✓ Trees which have heavy tops or which are over six feet in height shall be staked, guyed, or anchored to prevent winds from loosening the roots.
- ✓ All plant roots should be soaked thoroughly with water at planting time and once a week during the first growing season (unless soaking rains occur).
- ✓ Prune and remove broken or dead limbs/ branches from trees and shrubs after planting. Retain natural shape of plant.
- ✓ The central leader of trees should not be removed.
- ✓ See planting details for further information.

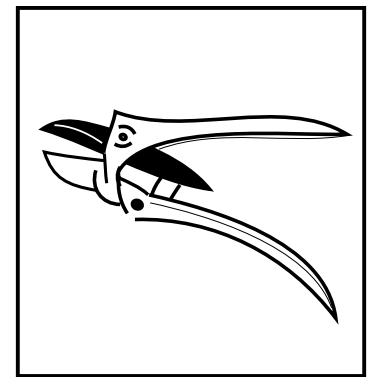
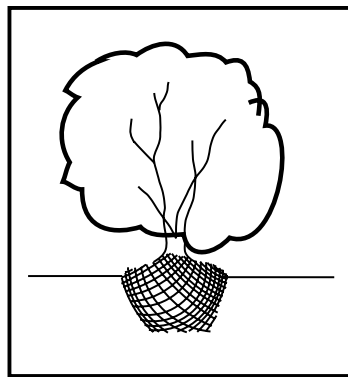
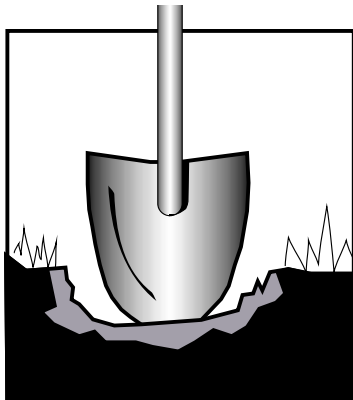

Roadsides are hostile environments for plant establishment and development. Sub-soils are generally encountered and these contain minimal plant nutrients. The water for highway plants depends largely upon rainfall since there is limited opportunity for irrigation. Automobile emissions may be detrimental to many plant species. Selection of appropriate plant material, that will survive in the roadside environment, is an important element in undertaking a highway planting project.

Tree or Shrub Planting Detail

level ground

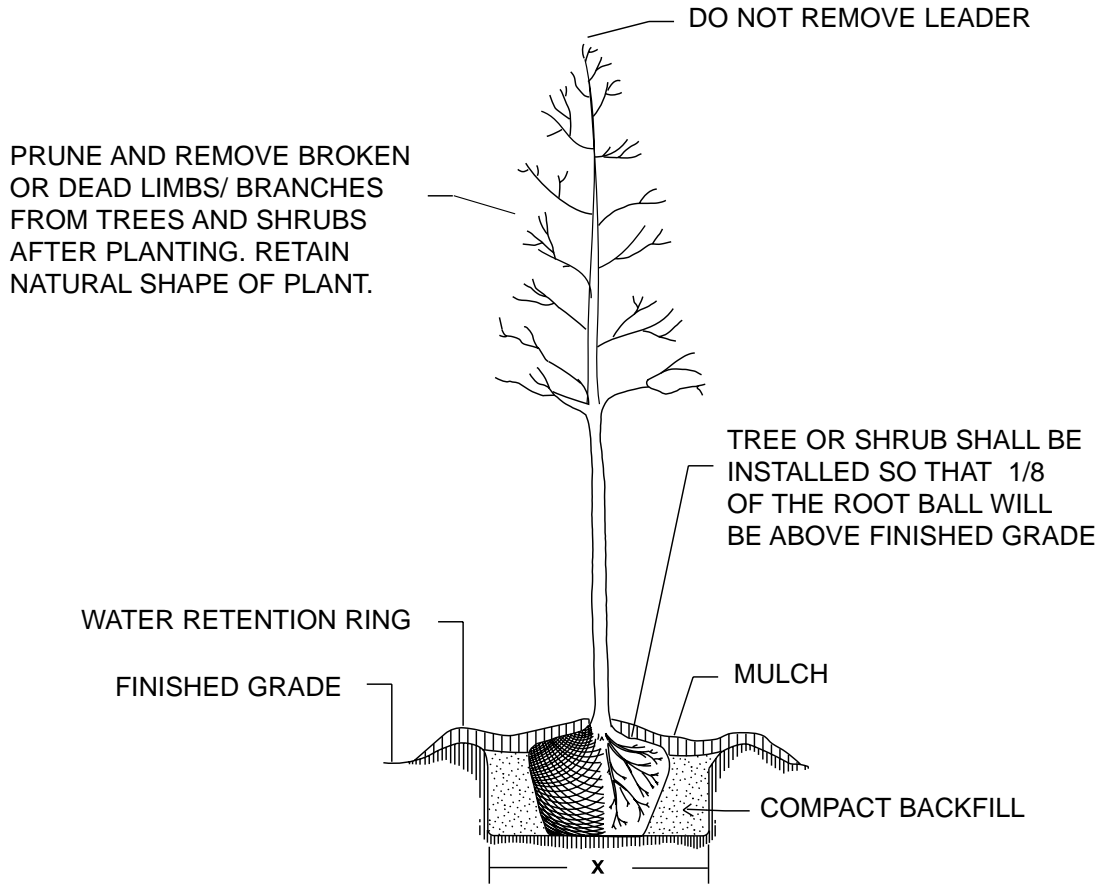

X = 2 TIMES THE DIAMETER OF THE CONTAINER OR THE ROOT BALL DIAMETER

Shrub Bed Planting Detail

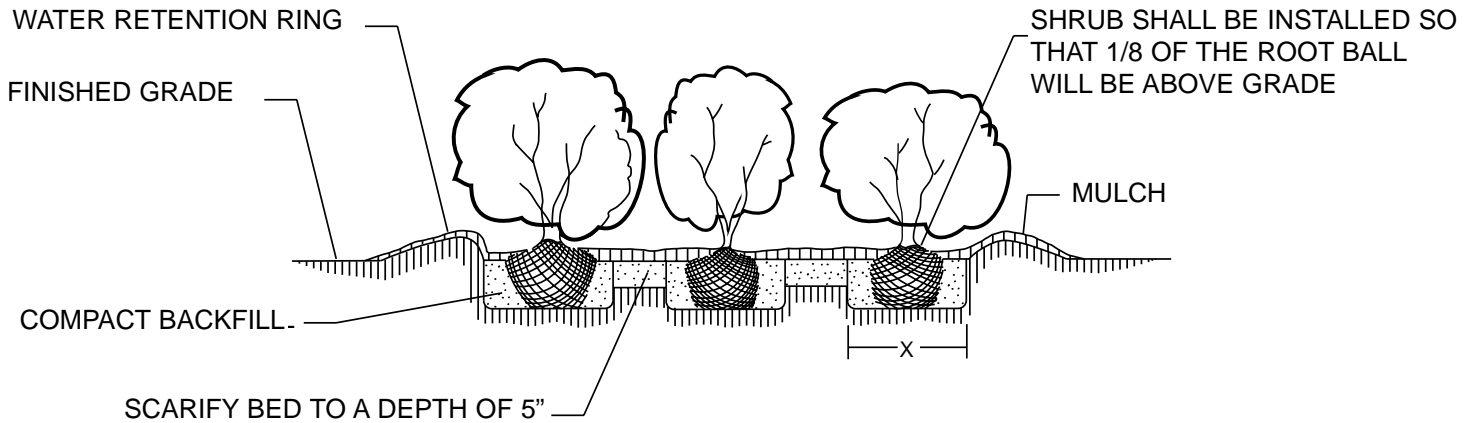

X = 2 TIMES THE DIAMETER OF THE CONTAINER OR THE ROOT BALL DIAMETER

Tree or Shrub Planting Detail

sloping ground

PRUNE PROPORTIONATELY TO COMPENSATE FOR REDUCTION OF ROOTS AND TO PROMOTE NATURAL CHARACTER OF GROWTH

WATER RETENTION RING
FINISHED GRADE

TREE OR SHRUB SHALL BE INSTALLED SO THAT 1/8 OF THE ROOT BALL WILL BE ABOVE FINISHED GRADE

COMPACT BACKFILL

MULCH

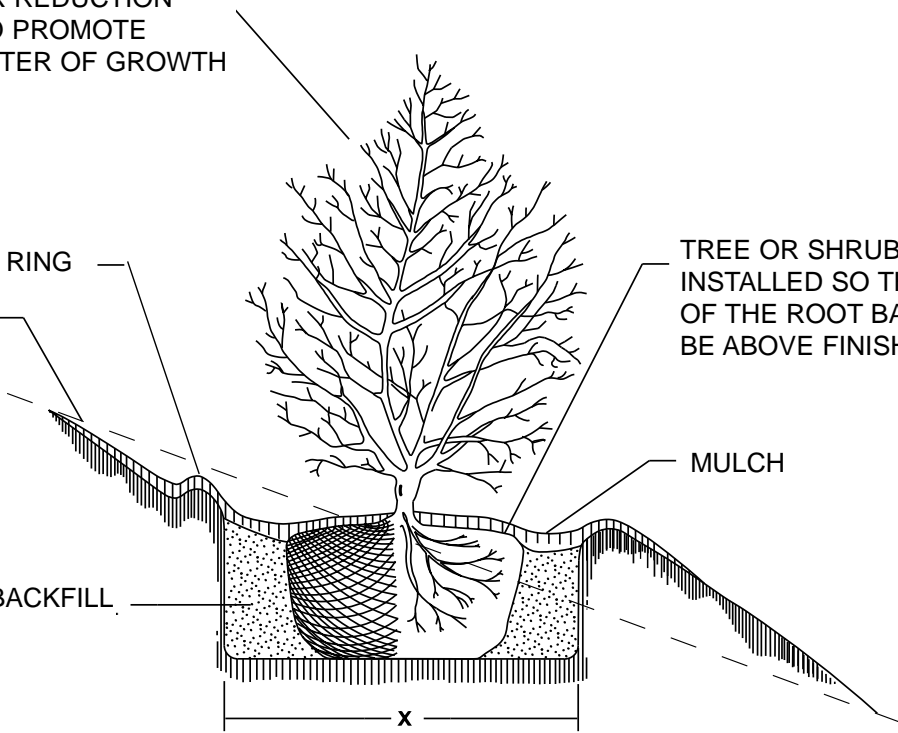

$X = 2$ TIMES THE DIAMETER OF THE CONTAINER
OR THE ROOT BALL DIAMETER

Ground cover/ Perennial/ Annual Planting Detail

PLANTS MAY BE PLANTED EITHER BEFORE OR AFTER MULCHING OPERATION

4" MULCH

FINISHED GRADE

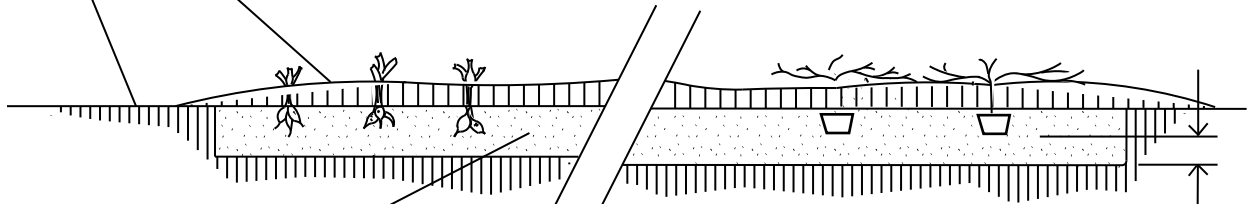

SCARIFY TO A MINIMUM DEPTH OF 5" OR 2" DEEPER THAN CONTAINER

Staking Detail

for trees 6 to 10

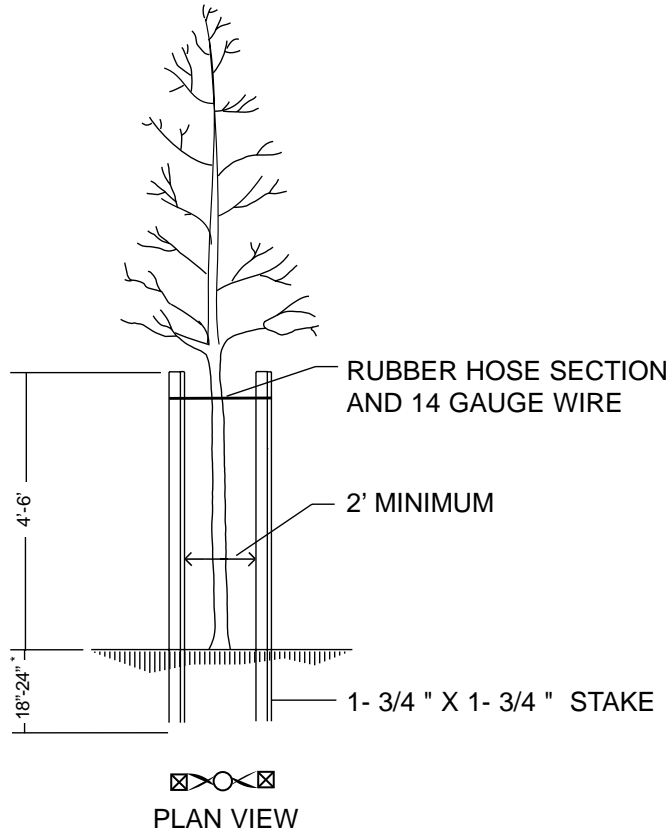

*EXACT LENGTH (WITHIN INDICATED RANGE) TO BE DETERMINED BY ENGINEER IN THE FIELD

Tree Guying Detail

for trees 10 or larger

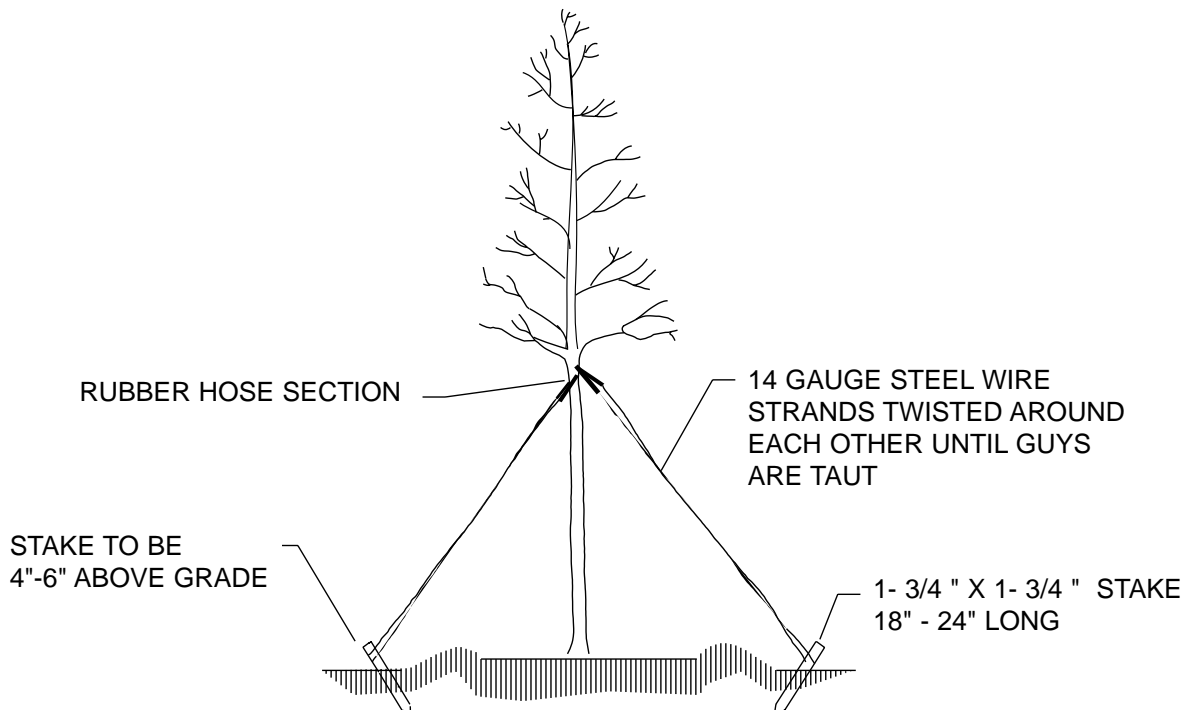

Common Plants Used By NCDOT

The list below represents a sampling of hardy plants used in landscape application on North Carolina roadsides. Plants are listed by botanical (Genus/ species) and common name. Only 'standard' plant names are listed. Many plants have exceptional cultivars that may have qualities more desirable than the 'standard'. Check with local nurseries for superior cultivars, plant adaptability to the location, plant availability, and the best use of the specific plants.

When possible, the Department promotes the practical use of native species.

No planting on state right-of-way is allowed without written approval from your local North Carolina Department of Transportation Division office.

TREES

- Acer rubrum, Red Maple- D, LT, XFC
Acer saccharum, Sugar Maple- D, LT, XFC
Amelanchier arborea, Downy Serviceberry, D, ST, FL, FR, BK, XFC
Betula nigra, River Birch- D, LT, BK
Cercis canadensis, Eastern Red Bud- D, ST, FL
Chionanthus virginicus, White Fringetree- D, ST, FL, FR
Cladrastis lutea (kentukea)- American Yellowwood- LT, FL, XFC
Cornus florida, Flowering Dogwood- D, ST, FL, FR, XFC
Cryptomeria japonica, Japanese Cryptomeria- E, LT, H/S
Fagus grandiflora, American Beech- D, LT, FR, BK, XFC
Fraxinus pennsylvanica, Green Ash- D, LT
Halesia carolina, Carolina Silverbell- D, LT, FL, FR
Juniperus virginiana- Eastern Red Cedar- E, LT, H/S
Koelreuteria paniculata, Golden Raintree- D, LT, FL, FR, XFC
Lagerstroemia indica, Crape Myrtle (come in a great selection of sizes, colors, and shapes)- D, ST, FL, BK, XFC
Lagerstroemia fauriei, Japanese Crape Myrtle-cultivars are highly resistant to mildew and more cold hardy)- D, ST, FL, BK, XFC
Liquidambar styraciflua, Sweetgum (the fruitless variety may be more practical for residential use)- D, LT, FR, XFC
Liriodendron tulipifera, Tulip Poplar- D, LT, FL, XFC
Magnolia grandiflora, Southern Magnolia- E, LT, FL, FR, H/S
Magnolia- a large selection of deciduous native and cultivated magnolia species are worthy of use- LT to ST, FL, FR, BK
Malus, Flowering Crabapple- variety of sizes fit well into the landscape (research selection for disease and insect resistance) - D, ST, FL, FR
Metasequoia glyptostroboides, Dawn Redwood- D, LT, H/S, XFC
Nyssa sylvatica, Black Gum- D, LT, FR, BK, XFC
Oxydendrum arboreum, Sourwood- D, ST, FL, FR, BK, XFC
Picea abies, Norway Spruce- E, LT, FR
Pinus strobus, White Pine- E, LT, H/S
Pinus taeda, Loblolly Pine- E, LT
Pinus thunbergiana, Japanese Black Pine- E, LT

KEY:

E-evergreen
D-deciduous
LT- large tree
ST- small tree
LS- large shrub
MS- medium shrub
SS- small shrub
G-groundcover
FL- conspicuous flower
FR- conspicuous fruit
BK- attractive bark or stem color
H/S-good hedge/screen
XFC- exceptional fall color

SIZE CATEGORIES

(based on average size at maturity)
LT (Large Tree): 30'- taller
ST (Small Tree): 15'- 30'
LS (Large Shrub): 8'-taller
MS (Medium Shrub): 4'- 8'
SS (Small Shrub): less than 4'



Pinus virginiana, Virginia Pine- E, LT, H/S
Pistacia chinensis, Chinese Pistachio- D, ST, FR, BK, XFC
Platanus x acerfolia, London Plane Tree (or Sycamore)- D, LT, FR, BK
Platanus occidentalis, American Plane Tree (or Sycamore)- D, LT, FR, BK
Prunus cerasifera, Flowering Plum- D, ST, FL
Prunus mume, Japanese Apricot- D, ST, FL
Prunus serrulata, Japanese Flowering Cherry- D, ST, FL, BK
Prunus subhirtella, Higan Cherry- D, ST, FL, FR, BK
Prunus x yedoensis- Yoshino Cherry- D, LT, FL, FR, BK
Quercus alba, White Oak, D, LT,
Quercus acutissima, Sawtooth Oak- D, LT, FR
Quercus coccinea, Scarlet Oak- D, LT, FR, XFC
Quercus falcata, Southern Red Oak- D, LT, FR
Quercus palustris, Pin Oak- D, LT, FR, XFC
Quercus phellos, Willow Oak- D, LT, FR
Quercus virginiana, Live Oak- E, LT, FR
Sophora japonica, Japanese Sophora- D, LT, FL, FR
Taxodium distichum, Bald Cypress- E, LT, BK, XFC
Tsuga canadensis, Canadian (Eastern) Hemlock- E, LT, FR, H/S
Tsuga caroliniana, Carolina Hemlock- E, LT, FR, H/S
Vitex agnus-castus, Chastetree (or Vitex)- D, ST, FL
Zelkova serrata, Japanese Zelkova- D, LT, BK, XFC

KEY:

E-evergreen
 D-deciduous
 LT- large tree
 ST- small tree
 LS- large shrub
 MS- medium shrub
 SS- small shrub
 G-groundcover
 FL- conspicuous flower
 FR- conspicuous fruit
 BK- attractive bark or stem color
 H/S-good hedge/screen
 XFC- exceptional fall color

SIZE CATEGORIES

(based on average size at maturity)

LT (Large Tree): 30' - taller

ST (Small Tree): 15' - 30'

LS (Large Shrub): 8' -taller

MS (Medium Shrub): 4' - 8'

SS (Small Shrub): less than 4'

SHRUBS, ETC.

Abelia x grandiflora- Glossy Abelia (many wonderful cultivars)- E, MS, FL, H/S
Aesculus parviflora, Bottlebrush Buckeye- D, LS, FL, FR
Aronia arbutifolia, Red Chokeberry- D, LS, FR, XFC
Berberis thunbergii, Japanese Barberry- D, MS, FR, XFC
Buddleia davidii, Butterfly-bush- D, MS, FL
Callicarpa americana, American Beautyberry- D, MS, FL, FR
Callicarpa dichotoma, Purple Beautyberry- D, SS, FL, FR
Caryopteris x clandonensis, Bluebeard (or Blue-spirea)- D, SS, FL
Chaenomeles speciosa, Common Flowering Quince- D, LS, FL, FR
Clethra alnifolia, Summersweet- D, MS, FL, FR, XFC
Cornus alba, Tatarian Dogwood- D, LS, BK, XFC
Cornus sericea, Redosier Dogwood – D, LS, BK, XFC
Cotinus coggygria, Smokebush (or Smoke Tree)- D, LS (ST), FL, XFC
Elaeagnus pungens, Thorny Elaeagnus- E, LS, H/S
Euonymus alata 'compacta', Compact Burning-bush- D, LS, FR, BK, H/S, XFC
Forsythia x intermedia, Border Forsythia- D, LS, FL
Fothergilla gardenii, Dwarf Fothergilla- D, SS, FL, XFC
Hamamelis virginiana, Witchhazel- D, LS (ST), FL, XFC
Hamamelis x intermedia- group of hybrid Witchhazels- D, LS (ST), FL, XFC
Hemerocallis- Daylily (thousands of varieties available)- D to E, G, FL

Hydrangea quercifolia, Oakleaf Hydrangea- D, MS, FL, XFC
 Hypericum frondosom, Golden St. Johnswort- D, SS, FL
 Ilex x attenuata- group of hybrid hollies (Foster)- E, LS (ST), FR, H/S
 Ilex cornuta, Chinese Holly- E, LS, FR, H/S
 Ilex crenata, Japanese Holly- E, LS, H/S
 Ilex glabra, Inkberry- E, LS, FR, H/S
 Ilex latifolia, Lusterleaf Holly- E, LS (ST), FR, H/S
 Ilex opaca, American Holly (good selection of upright hollies)- E, LS (ST), FR, H/S
 Ilex verticillata, Winterberry- D, LS, FR
 Ilex vomitoria, Yaupon Holly- E, LS (ST), FR, H/S
 Ilex x 'Nellie R. Stevens', Nellie R. Stevens Holly- E, LS (ST), FR, H/S
 Itea virginica, Virginia Sweetspire- D, MS, FL, XFC
 Jasminum nudiflorum, Winter Jasmine- D, SS, FL
 Juniperus- multitude of junipers ideal for various landscape uses- E, LS to G
 Kerria japonica, Japanese Kerria- D, MS, FL
 Lagerstroemia- many smaller (shrubby) Crape Myrtles are introduced annually-
 D, SS(MS), FL, XFC
 Liriope muscari, Big Blue Liriope- E, G
 Loropetalum chinense, Loropetalum- E, LS, FL, H/S
 Myrica cerifera, Southern Wax Myrtle- E, LS, FR, H/S
 Myrica pensylvanica, Northern Bayberry- E, LS, FR, H/S
 Osmanthus x fortunei, Fortune's Osmanthus- E, LS, FL, H/S
 Pyracantha coccinea, Scarlet Firethorn- E, LS, FL, FR, H/S
 Pyracantha koidzumii, Formosa Firethorn- E, LS, FL, FR
 Raphiolepis umbellata (indica), Indian Hawthorn- E, MS, FL, FR
 Spiraea cantoniensis, Reeves Spirea- D, MS, FL
 Spiraea x bumalda- Bumald Spirea- D, SS, FL
 Taxus x media, Spreading Yew- E, height varies, FR, H/S
 Ternstroemia gymnanthera, Japanese Cleyera (also sold as Cleyera japonica)- E, LS, FL, FR, H/S, XFC
 Viburnum- multiple species and cultivars worthy of use- E to D, LS to MS, FL, H/S
 Weigela florida, Weigela (various sizes, colors, etc.)- D, LS, FL

KEY:

E-evergreen
 D-deciduous
 LT- large tree
 ST- small tree
 LS- large shrub
 MS- medium shrub
 SS- small shrub
 G-groundcover
 FL- conspicuous flower
 FR- conspicuous fruit
 BK- attractive bark or stem color
 H/S-good hedge/screen
 XFC- exceptional fall color

SIZE CATEGORIES

(based on average size at maturity)
 LT (Large Tree): 30'- taller
 ST (Small Tree): 15'- 30'
 LS (Large Shrub): 8'-taller
 MS (Medium Shrub): 4'- 8'
 SS (Small Shrub): less than 4'

